





>N7F%\*

%&+ %\$&\$ A<n

CC? fl; Ł: G?

~~>N7F%\*~~

>N7F%\*

\*(! VmnhY Fl : =: Cž ? ; D=C

8i hmł 7mWY

a

FGG=

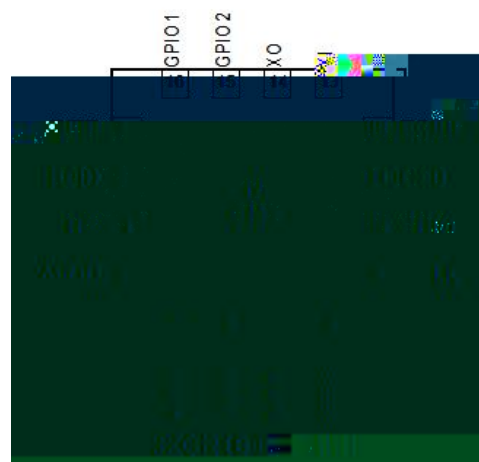



---

---

1.	.....	4
% %	.....	4
% &	.....	4
% '	.....	4



---

%'

J881 ' "' J Hb1 &) : F: 1 ( ' "' - & A<n  
\$" % 69F

DB- )\$ »  
>N7F%\*! 9A

% %

%

% & )



---

%'

''

% ('



('

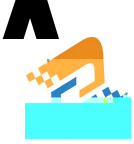



---

%)

)"

% \*

\*"



% ,

,



% -

-



% %\$

%\$"





&"

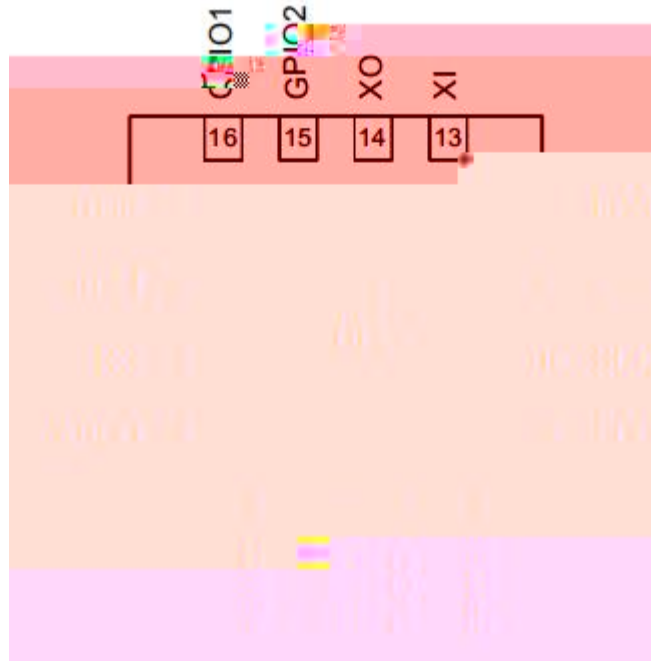

%! >N7F%

%% >N7F%







O

@B5ZA FZ=: :=@H9F A=HH9FZD@@

%

@a]hYf

FGG=      =#E  
          , !V]h

; :G?  
CC?

587



A71 >N7F%\* DCF >N7F%\* DCF  
 \$" -J &\$i \$" +&! %" \$, J J88 & i g J88  
 J88 J88 J88

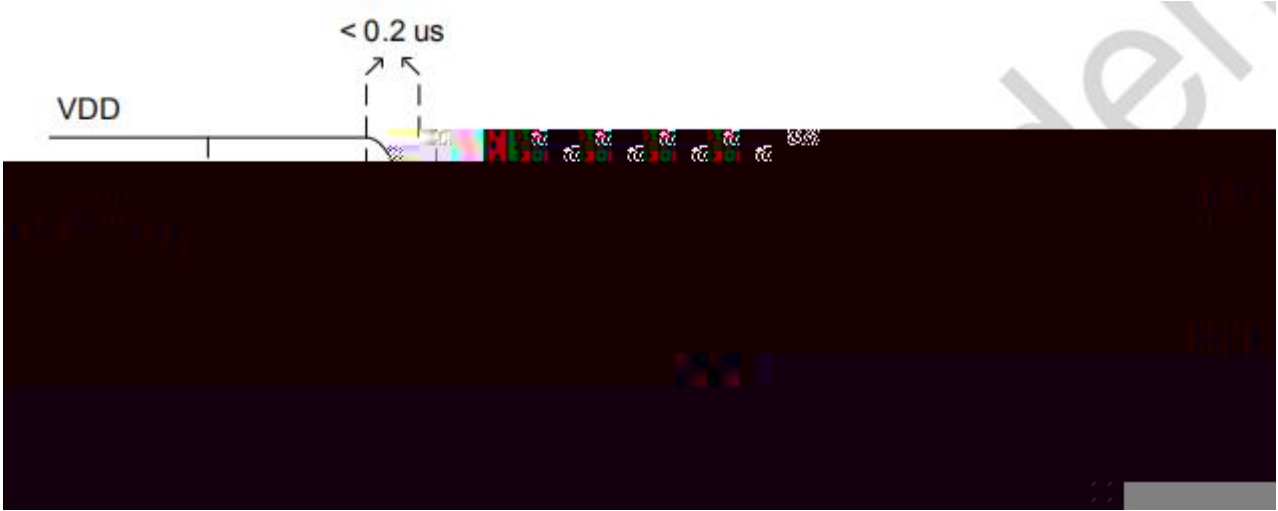

(" J88 DCF & i g % ( ) J &\$i  
 %" %\* J %" +(J J88 J88



)" DCF

(" &" &

L= LC

7@

7@

$$C_L = \frac{1}{1/C_{11} + 1/C_{12}} + C_{par} + 2.5pF$$



7)

7%\*

7dUf

D76

) d:

0%

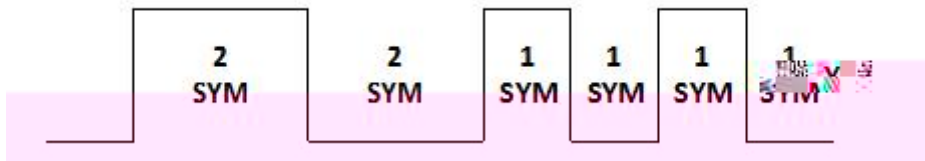



(

D>8

8Yj ] Uh] cb  
8Yj ] Uh] cb GBF

GBF

+X6

%

\$

FGG= J@8

G@d

8Cl HSAI H9

%

D>8

: G?

D>8

7G

7G

FGG=

D>8

(" &" +

5: 7

5: 7

HL

FL

>N7F%\*



: <SC : G9HO+. \$2

: <S7<5BB9@0+. \$2

)"

)" % GD=

( GD= 7G6  
: 7G6 : =: C G7@  
) A<n A7I G7@  
G8=C AG6  
7G6 F#K +  
A7I 7G6 G7@

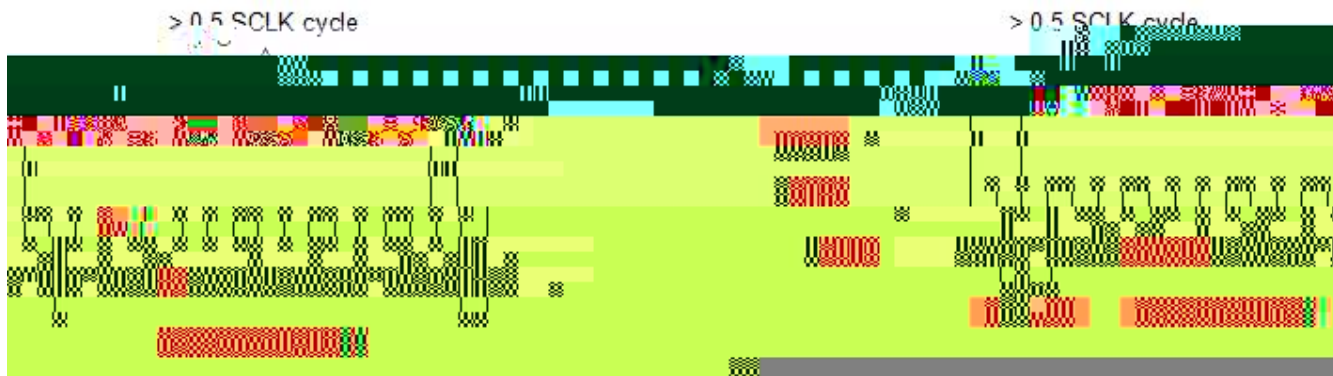
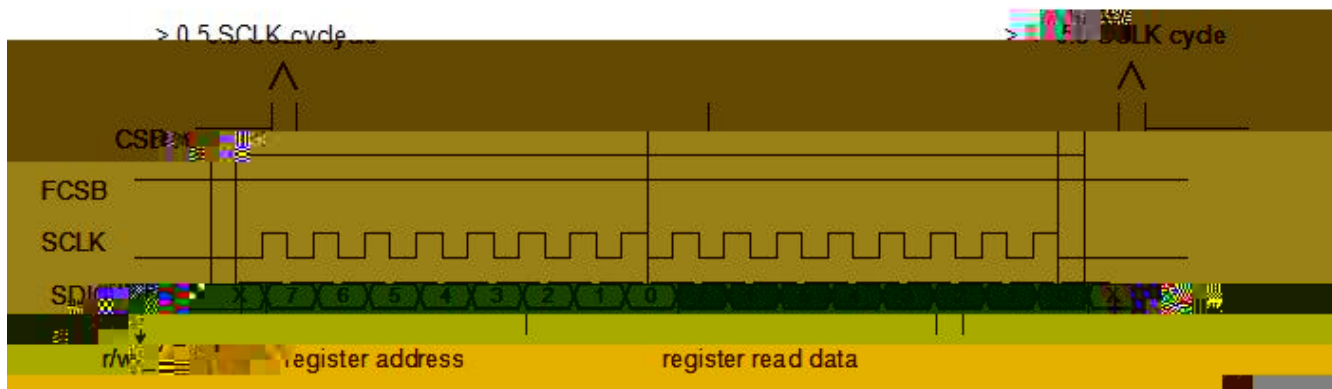



: =: C

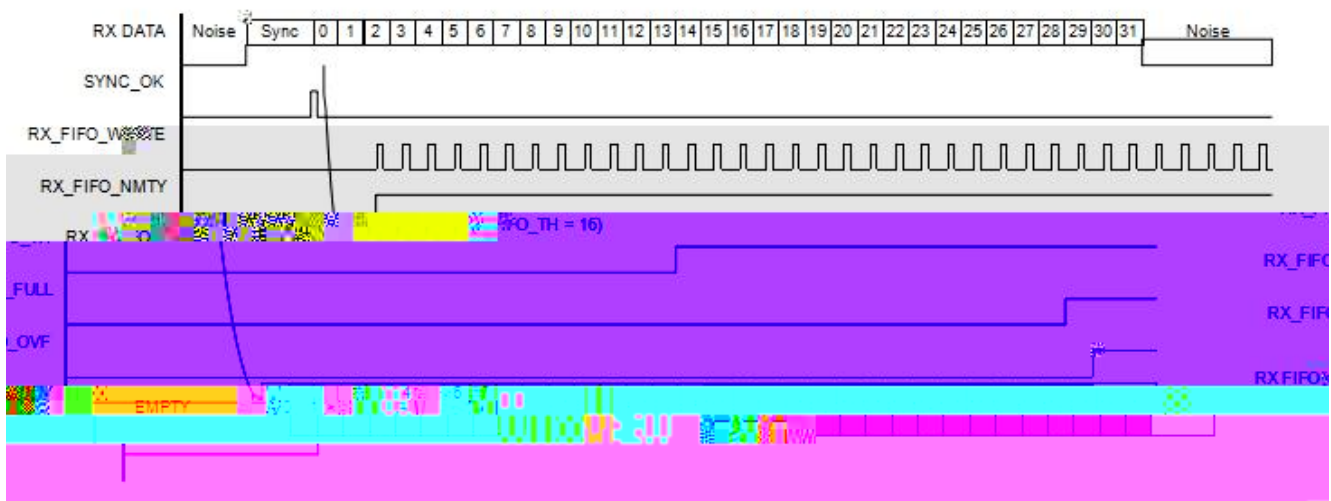
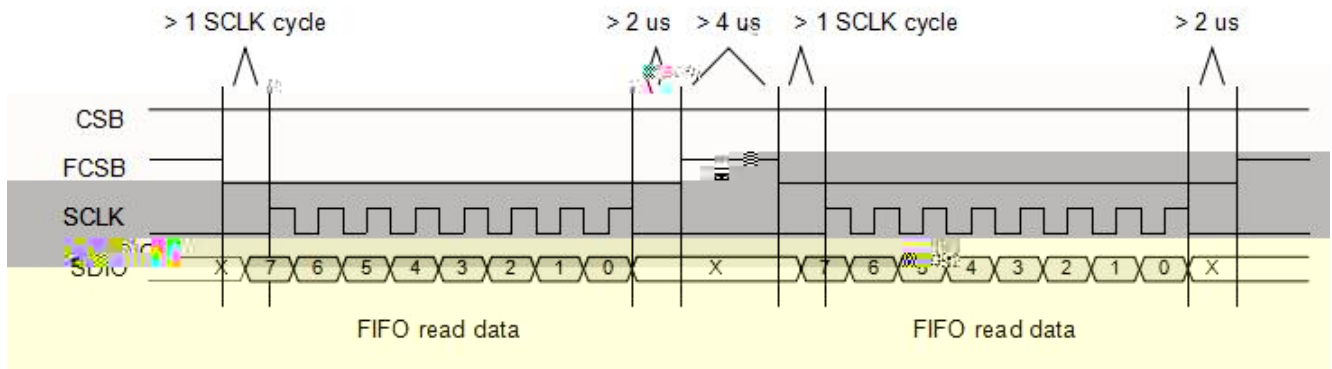



ag

=8@9

=8@9

G@99D

=8@9

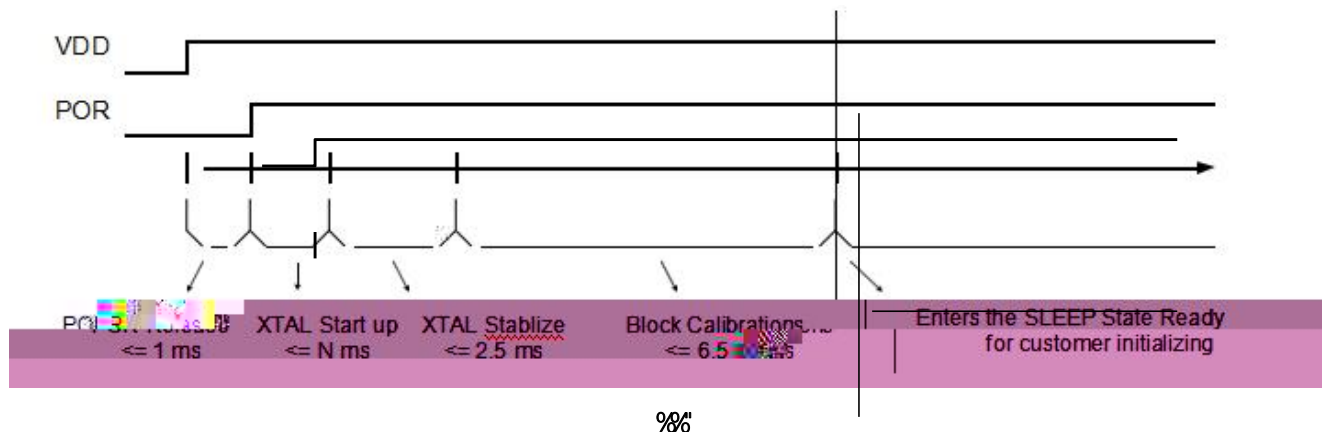

%"

G@99D

A7I

7<=DSAC89SGKHO+. \$2

)'" "&

>N7F%\*

)

=8@9ž G@99Dž GH6Mž F: Gž FL

% "

IDLE	0000	soft_rst	SPI, POR	
SLEEP	0001	go_sleep	SPI, POR, FIFO	IFOSC, Sleep Timer
STBY	0010	go_stby	SPI, POR, XTAL, FIFO	CLKO
RFS	0011	go_rfs	SPI, POR, XTAL, PLL, FIFO	CLKO
RX	0101	go_rx	SPI, POR, XTAL, PLL, INA+MIXER+IF, FIFO	CLKO, RXTimer

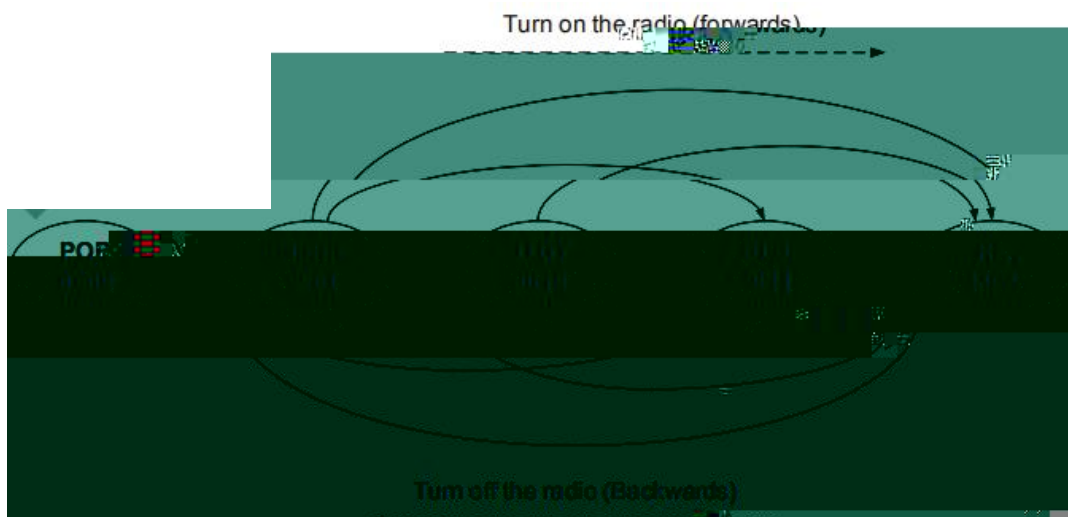

%&"

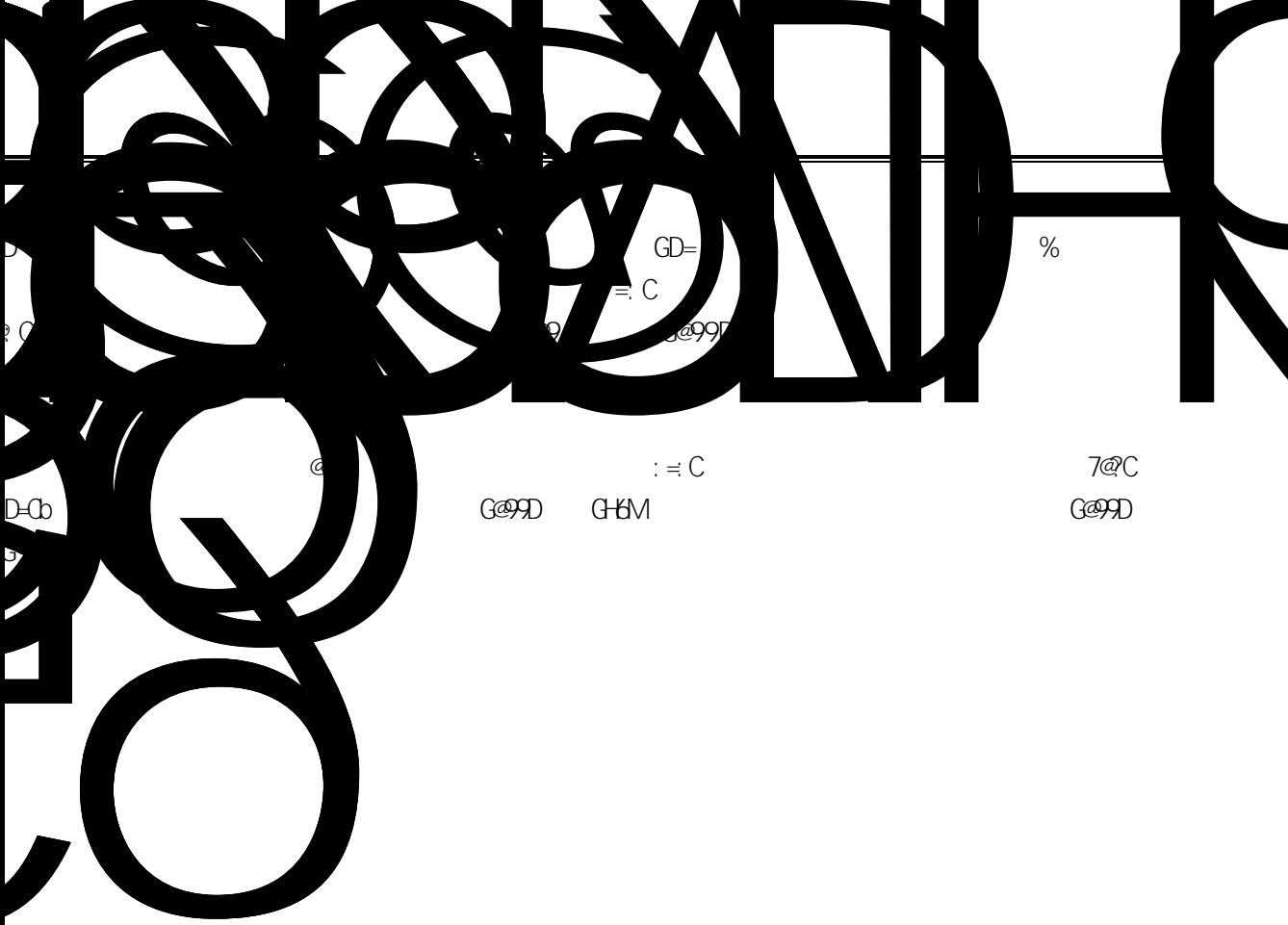

D

2 C

D=Cb

5

GD=

= C

9

3@997

%

@

: = C

G@9D

G6M

7@C

G@9D



% " >N7F%\*

%

=B-S00@F

%

\$

\* "

8UhU AcXY

A7I

>N7F%\*

8] fYVh

dfYUaV' Y

gmbW

: =: C

DUW\_Yh

: =: C



\*" %

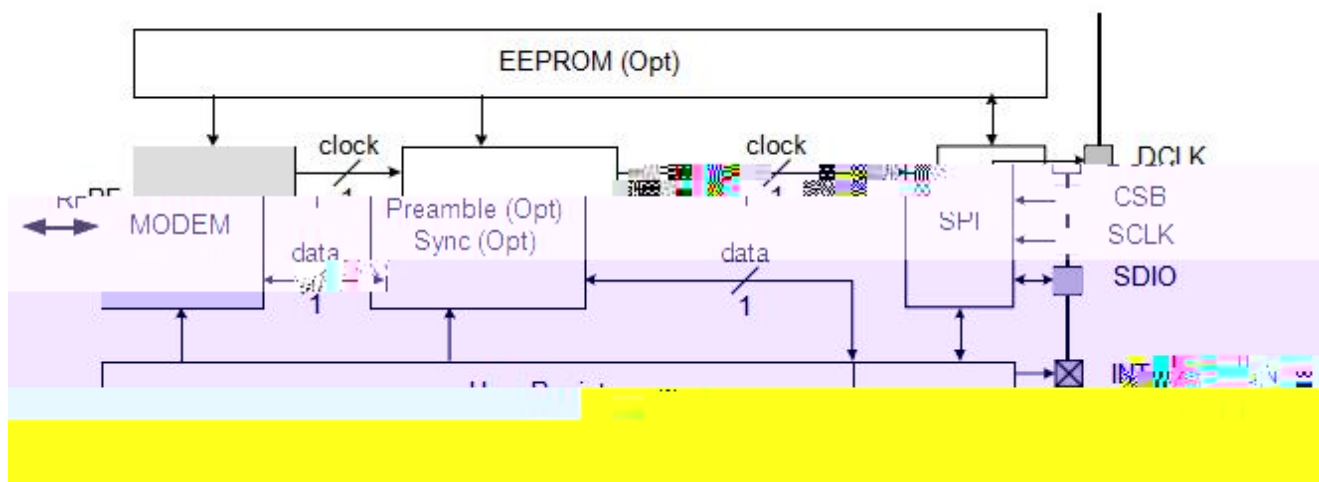

% "

FI

7I GS=CSG9@f15XXf1\$! \*) Ł

8CI H

A7I ž 8CI H

; D=C%ž & ' "

; D=Cg



---

%\* " @Yb[ h\ BcXY =8

%t " @Yb[ h\ BcXY =8

% "

<



+ " &

G@d

>N7F%\*  
@ck DckYf  
G@d

FLSH=A9FS9B

% FL  
FL

G@d Gi ddYf

FL

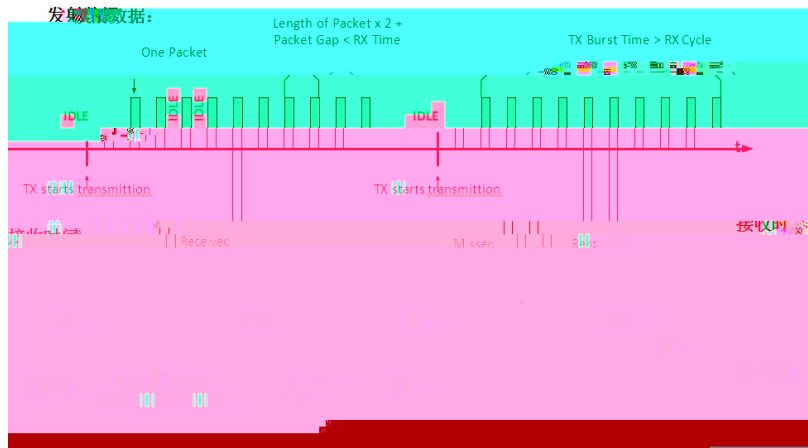

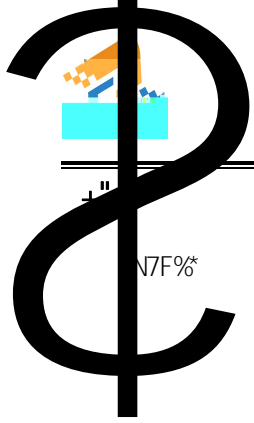

---

JG

N7F%\*

F: a



- "

&&" >N7F%